

# APPLICATION NOTE

## How to Determine the Modal Parameters of Simple Structures

by Svend Gade, Henrik Herlufsen and Hans Konstantin-Hansen, Brüel & Kjær, Denmark

The modal parameters of simple structures can be easily established by the use of PULSE™, the Multi-analyzer System Type 3560. This application note describes how to measure the modal frequencies by inspection of frequency response functions, how to determine the modal damping with the aid of the frequency weighting function included in the analyzer, and how to establish the mode shapes by examining the value of the imaginary part of the frequency response function.

The frequency response function of a structure can be separated into a set of individual modes. By using a PULSE Multi-analyzer System Type 3560, each mode can be identified in terms of frequency, damping and mode shape.

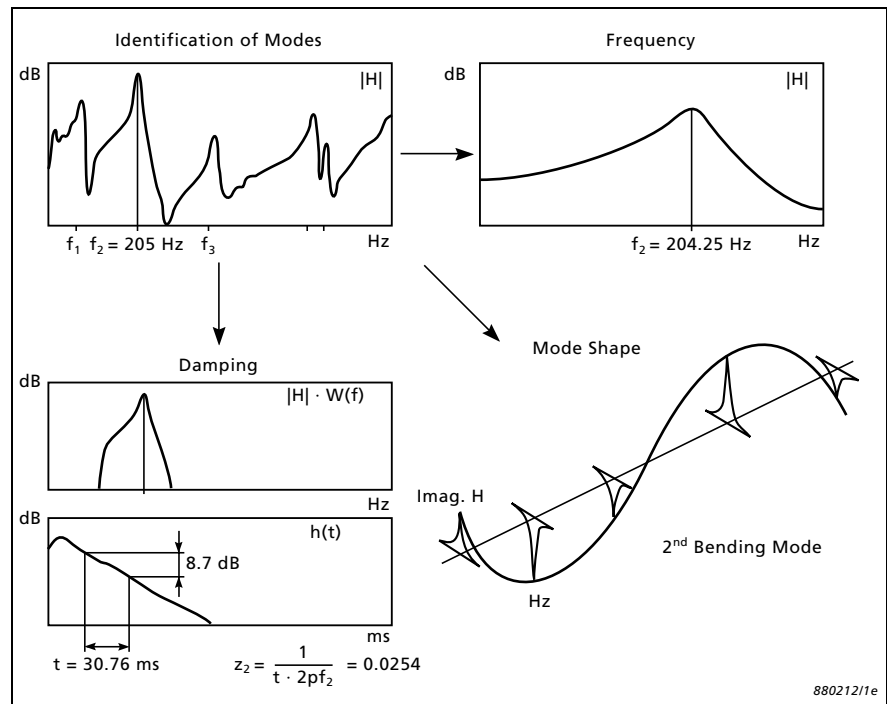

## Introduction

In practice, nearly all vibration problems are related to structural weaknesses, associated with resonance behaviour (that is natural frequencies being excited by operational forces). It can be shown that the complete dynamic behaviour of a structure (in a given frequency range) can be viewed as a set of individual modes of vibration, each having a characteristic natural frequency, damping, and mode shape. By using these so-called modal parameters to model the structure, problems at specific resonances can be examined and subsequently solved.

The first stage in modelling the dynamic behaviour of a structure is to determine the modal parameters as introduced above:

- The resonance, or modal, frequency
- The damping for the resonance – the modal damping
- The mode shape

3560

The modal parameters can be determined from a set of frequency response measurements between a reference point and a number of measurement points. Such a measurement point, as introduced here, is usually called a Degree-of-Freedom (DOF). The modal frequencies and dampings can be found from all frequency response measurements on the structure (except those for which the excitation or response measurement is in a nodal position, that is, where the displacement is zero). These two parameters are therefore called “Global Parameters”. However, to accurately model the associated mode shape, frequency response measurements must be made over a number of Degrees-of-Freedom, to ensure a sufficiently detailed covering of the structure under test.

In practice, these types of frequency response measurements are made easy by using a Dual Channel Signal Analyzer such as the standard two-channel configuration of PULSE, the Multi-analyzer System Type 3560. The excitation force (from either an impact hammer or a vibration exciter provided with a random or pseudorandom noise signal) is measured by a force transducer, and the resulting signal is supplied to one of the inputs. If a vibration exciter is used, a generator module should be installed in the analyzer. The response is measured by an accelerometer, and the resulting signal is supplied to another input. Consequently, the frequency response represents the structure’s acceleration since the measured quantity is the complex ratio of the acceleration to force, in the frequency domain. For impact hammer excitation, the accelerometer response position is fixed and used as the reference position. The hammer is moved around and used to excite the structure at every DOF corresponding to a DOF in the model. For vibration exciter excitation, the excitation point is fixed and is used as the reference position, while the response accelerometer is moved around on the structure. A typical instrumentation setup is illustrated in Fig. 1.

**Fig. 1**  
An instrumentation setup, using broadband pseudo-random force excitation provided by a vibration exciter

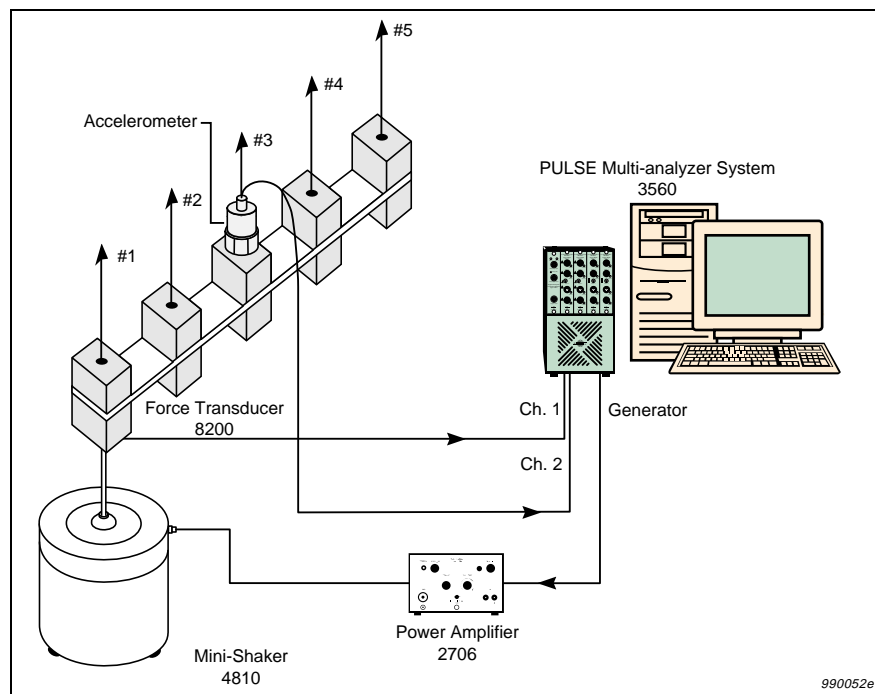

For structures defined with a large number of DOFs, the Multi-analyzer System Type 3560 can be equipped with up to eight four-channel modules (without expanding the physical dimensions of the system) to allow for easier and faster mobility measurements. Simultaneous measurement of up to 31 response signals and one force input signal can be performed, thereby greatly reducing the time needed to move the response accelerometer.

## Simple Structures

Structures which exhibit lightly coupled modes are usually referred to as simple structures. The modes are not closely spaced, and are not heavily damped (see Fig. 2). At resonance, a simple structure behaves predominantly as a Single-Degree-of-Freedom (SDOF) system, and the modal parameters can be determined relatively easily with a suitable configuration of the Brüel & Kjær PULSE Multi-analyzer System Type 3560.

**Fig. 2**  
The frequency response of simple structures can be split up into individual modes, each mode behaving as a single-degree-of-freedom system

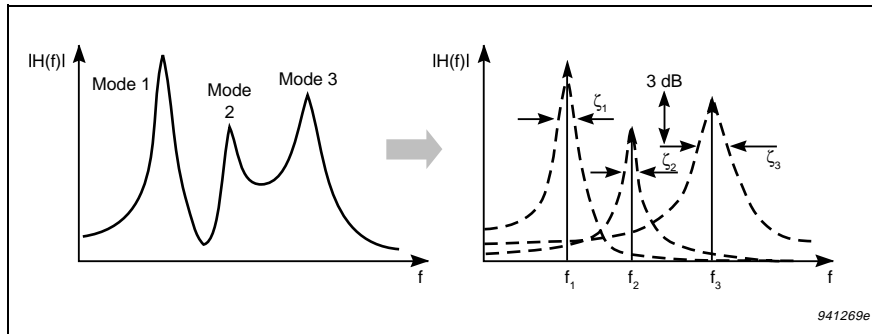

## Determination of the Modal Frequencies

**Fig. 3**  
Magnitude of the frequency response function (Accelerance) for the test structure

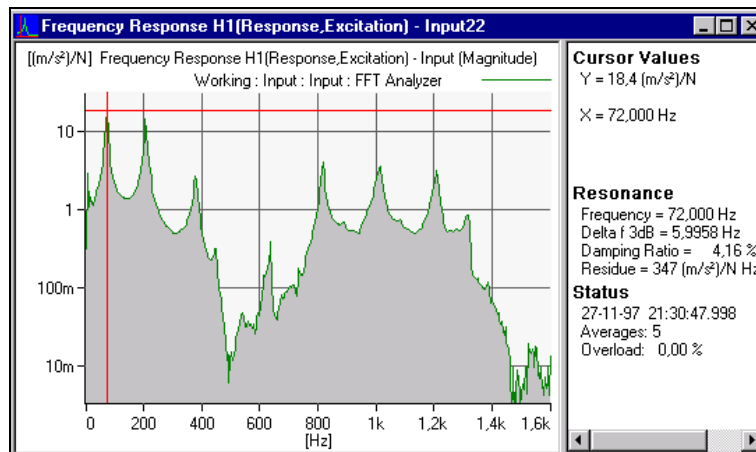

The resonance frequency is the easiest modal parameter to determine. A resonance is identified as a peak in the magnitude of the frequency response function, and the frequency at which it occurs is found using the analyzer's cursor as shown in Fig. 3.

**Fig. 4**  
Zoom measurement for achieving higher frequency resolution in the determination of the resonance frequency for the second mode. Determination of the damping for the second mode is identified by the half-power points and is read-out in the auxiliary cursor field

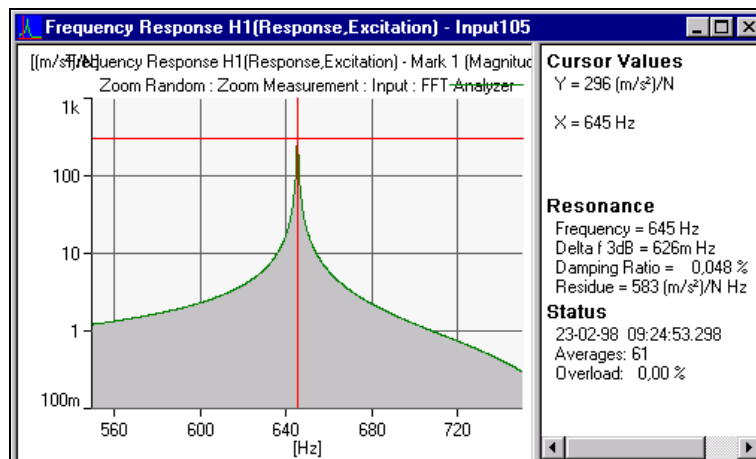

The frequency resolution of the analysis determines the accuracy of the frequency measurement. Greater accuracy can be attained by reducing the frequency range of the baseband measurement, for resonances at low frequencies, or making a zoom measurement around the frequency of interest, as shown in Fig. 4.

## Determination of the Modal Damping

The classical method of determining the damping at a resonance, using a frequency analyzer, is to identify the half power (−3 dB) points of the magnitude of the frequency response function (see Fig. 4). For a particular mode, the damping ratio  $\zeta_r$  can be found from the following equation:

$$\zeta_r = \frac{\Delta f}{2f_r}$$

where  $\Delta f$  is the frequency bandwidth between the two half power points and  $f_r$  is the resonance frequency. Type 3560 contains a built-in standard cursor reading which calculates the modal damping.

The accuracy of this method is dependent on the frequency resolution used for the measurement because this determines how accurately the peak magnitude can be measured. For lightly damped structures, high resolution analysis is required to measure the peak accurately, consequently, a zoom measurement at each resonance frequency is normally required to achieve sufficient accuracy. This means that a new measurement must be made for each resonance.

**Fig. 5**  
The frequency weighting function of the PULSE System allows a single mode to be isolated from the frequency response function.

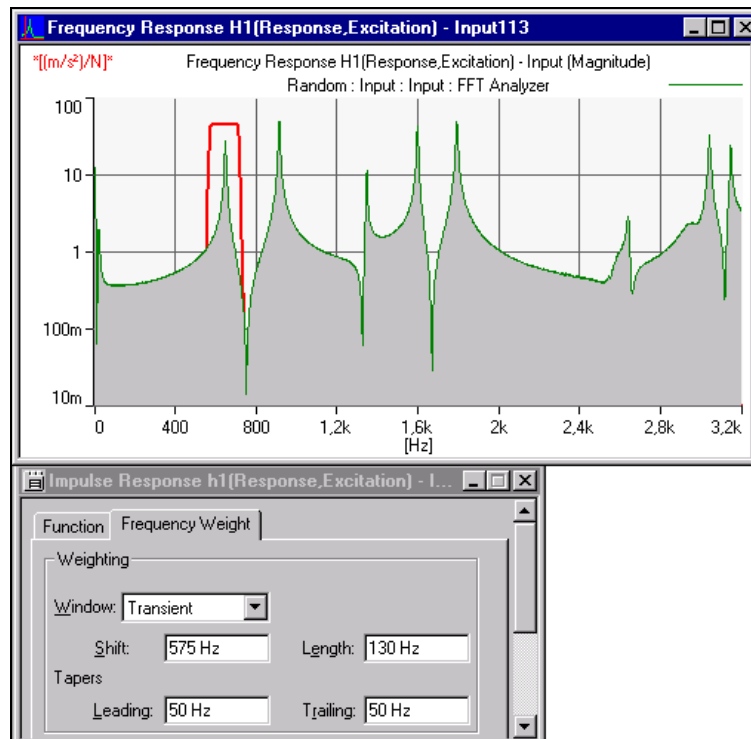

However, the PULSE System can be used to determine the damping ratio by an alternative method which requires no new measurements. By using a frequency weighting function (window) to isolate a single mode from the frequency response function (see Fig. 5), the impulse response function for that mode alone is easily produced. The magnitude (envelope) of the impulse response function can then be displayed by virtue of the Hilbert transform facility incorporated in the analyzers.

**Fig. 6**  
 The impulse response function of the isolated mode can be represented by its magnitude and displayed on a logarithmic scale to enable easy calculation of the damping

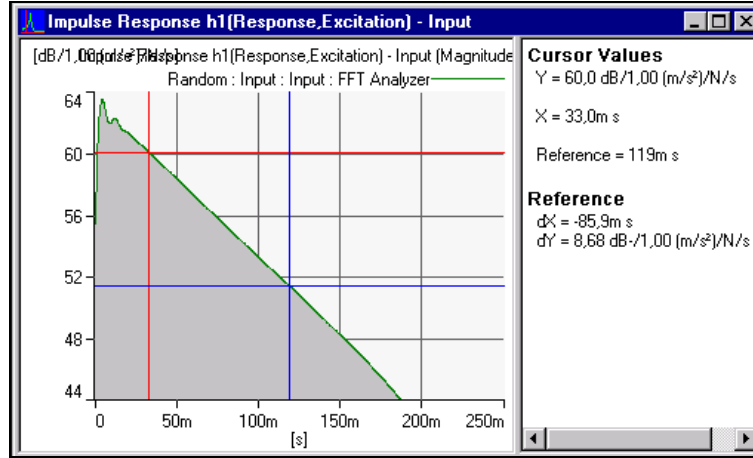

Since a simple structure behaves as a Single-Degree-of-Freedom system at each resonance, the impulse response function of the windowed resonance will show characteristic exponential decay  $\tau$ . By displaying the magnitude on a logarithmic scale the impulse response is represented by a straight line (see Fig. 6).

The decay rate  $\sigma_r$  for the isolated mode is related to the time constant  $\tau_r$  by:

$$\tau_r = \frac{1}{\sigma_r}$$

The decay corresponding to time constant  $\tau_r$  is given by the factor  $e^{-1}$ , or in dB:  $-20 \log_e = -8.7$  dB.

The damping ratio is related to the decay rate by:

$$\zeta_r = \frac{\sigma_r}{2\pi f_r} = \frac{1}{\tau_r 2\pi f_r}$$

By moving the frequency window through the frequency response function, and looking at each impulse response function in turn, the modal damping at each resonance can be determined from a single baseband measurement. Determination of the modal damping is immediately available by use of the main cursor and the reference cursor as illustrated in Fig. 6.

Applying pseudo-random excitation via a vibration exciter and using the above mentioned method, the damping value will be correct even though the resolution is low compared to the width of the resonance peak. See Ref. [1] for more details on this subject.

The decay rate, calculated from a frequency response function found by using hammer excitation, will be modified by the effective damping of the exponential weighting function applied to the response channel. This weighting function was added to curtail the structural ringing excited by the hammer impact. However, this error can easily be compensated for by using the following correction:

$$\sigma_r = \frac{1}{\tau_r} - \frac{1}{\tau_u}$$

where  $\tau_u$  is the time constant of the exponential weighting function.

## Determination of the Mode Shape

**Fig. 7**  
The first three modes of vibration for the test structure. The modal displacements are found from the imaginary part of the frequency response function

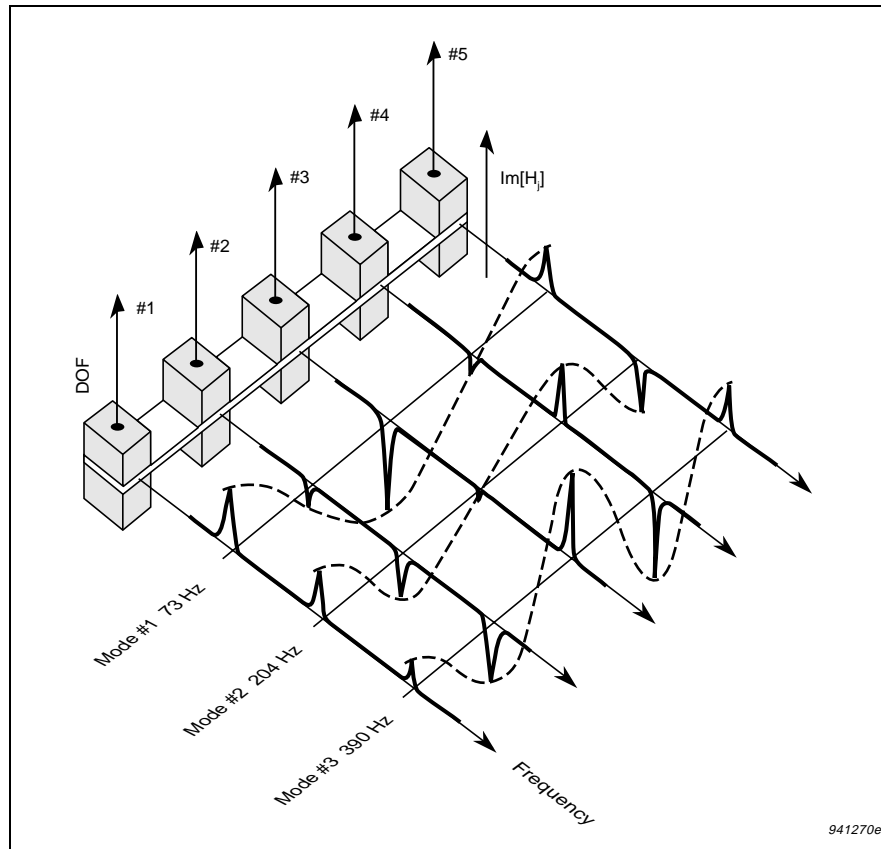

The simplest way of determining the mode shape for a structure is to use a technique called Quadrature Picking. Quadrature Picking is based on the assumption that the coupling between the modes is light. In practice, mechanical structures are often very lightly damped (<1%). This implies that the modes are lightly coupled. At any frequency, the magnitude of the frequency response function is the sum of the contributions (at the particular frequency) from all modes. When there is little modal coupling between the modes, the structural response at a modal frequency is completely controlled by that mode, and so Quadrature Picking can be used to unravel the mode shapes.

For Single-Degree-of-Freedom systems, the frequency response function (accelerance) at resonances is purely imaginary. As a result, the value of the imaginary part of the frequency response function at resonance, for structures with lightly coupled modes, is proportional to the modal displacement. Consequently, by examining the magnitude of the imaginary part of the frequency response function at a number of points on the structure, the relative modal displacement at each point can be found. From these displacements, the mode shapes can be established. The procedure can then be repeated to determine all the required mode shapes. By making an excitation and response measurement at the same point and in the same direction, the mode shape can be scaled in absolute units.

**Fig. 8**  
*The 3-D map of the imaginary part of the frequency response functions. The second mode of vibration is extracted by using the cursor*

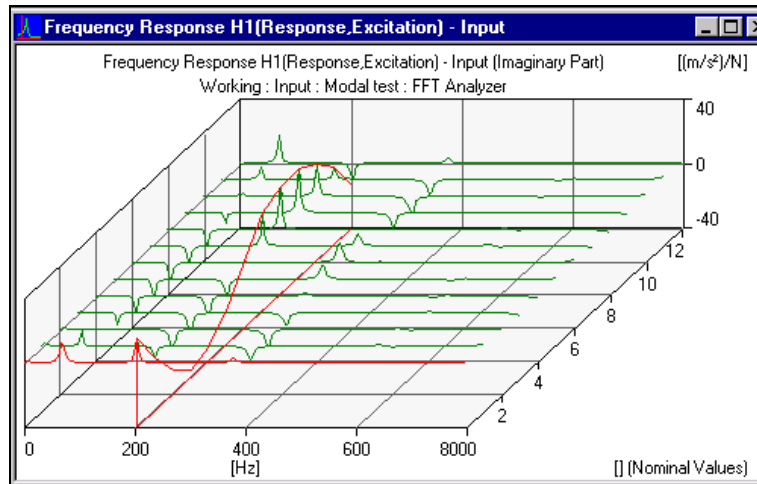

The mode shapes can be drawn by hand, or even simpler, the frequency response functions can be stored in a multi-buffer PULSE System and the mode shapes subsequently displayed by making slices in the multi-buffer as shown in Fig. 8. This technique is only meaningful when the structure under test can be represented by DOFs on a straight line (i.e., a one dimensional structure).

---

## Conclusions

---

PULSE, the Multi-analyzer System Type 3560, in its different configurations, is an ideal instrument for enabling the engineer to determine the modal parameters of simple structures. The modal frequencies are determined from the frequency response function. The modal dampings are found from the magnitude of the impulse response function, which is produced by isolating a single mode from the frequency response function, using a frequency weighting function. To obtain the mode shape, a technique called Quadrature Picking is used to evaluate the modal displacements at each point of interest. The modal displacements are found from the imaginary part of the frequency response function. The frequency response functions can be stored in a multi-buffer of the PULSE System and the mode shapes can subsequently be displayed by making slices in the buffer.

By adding the necessary software\* to the system, the modal parameters can be extracted using curve fitting techniques. Geometry models can be developed and mode shapes can be shown animated on the PC screen. The dynamic response due to excitation forces can be simulated and, furthermore, if the vibration characteristics of prototypes tested, using the PC based modal system, are unsatisfactory, then the influences of actual mass, stiffness and damping modifications can be simulated. In this way, a PULSE Multi-analyzer System Type 3560 can be expanded into a fully documented modal analysis system.

Data export is possible in a number of formats, such as Universal File ASCII, Universal File Binary, Standard Data Format and STAR binary. PULSE Bridge to ME'scope software Type 7755 A is available, which facilitates export from PULSE to ME'scope modal software (Type 7754), although the greatest testing and export flexibility is provided by Modal Test Consultant Type 7753.

---

\* Brüel & Kjær offers a complete palette of advanced Modal Analysis software packages to run on a PC. This palette covers software modules to be used for simple two channel modal analysis as well as software modules to be used for multichannel modal analysis. Add-on modules for prediction of dynamic response due to excitation forces and prediction of structural modifications are also available.

---

## References

---

- [1] S. Gade and H. Herlufsen, "Digital Filter Technique versus FFT Technique for damping measurements", Brüel & Kjær Technical Review No.1, 1994